

EMPTY NESTERS

EMPTY NESTERS

A house today is built under the assumption that a family (generally consisting of 2 parents and 3 children) will inhabit it. A master bedroom for the parents, a sitting room, a kitchen etc.

But it has become increasingly apparent to today's generation that the notion of 'family' is being severely challenged due to higher divorce rates, over population, less emphasis on religion etc.

We are compiling a pamphlet containing ideas/suggestions for an experimental, once off dwelling which will cater to the new definition of what family will mean in the near future.

This new family...

- is not necessarily blood related
- is flexible and will allow people to come and go
- promotes tolerance of different mindsets and religions
- caters to larger and smaller numbers at different times
- attempts to tackle the isolation prominent in many of today's neglected and elderly demographics.

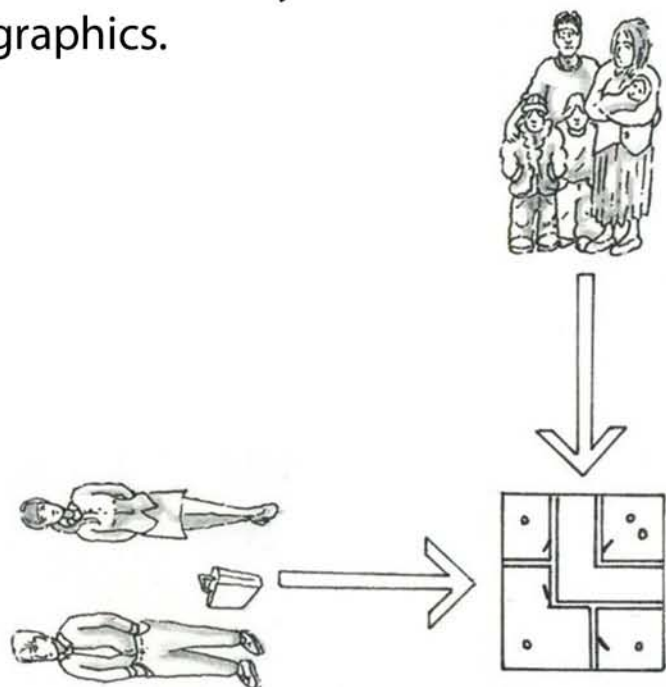
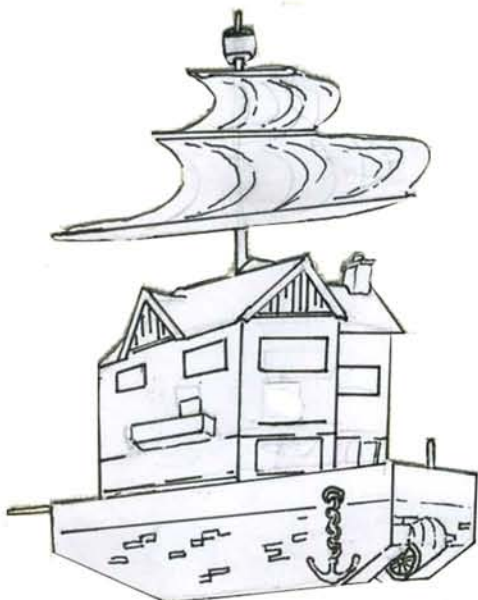

THE EVOLUTION OF FAMILY

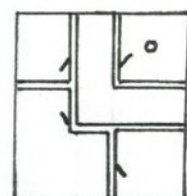
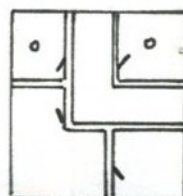
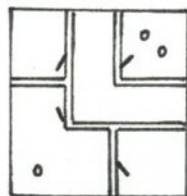
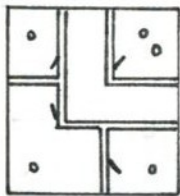
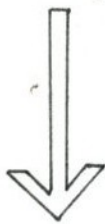

Security

People need to feel safe in this new family.
In the boat house deep window seats and a long sequence of spaces before entering a room helps to create that sense of enclosure. Family needs a protected space
A group of individuals living together.
where the individual is comfortable to express him/herself.

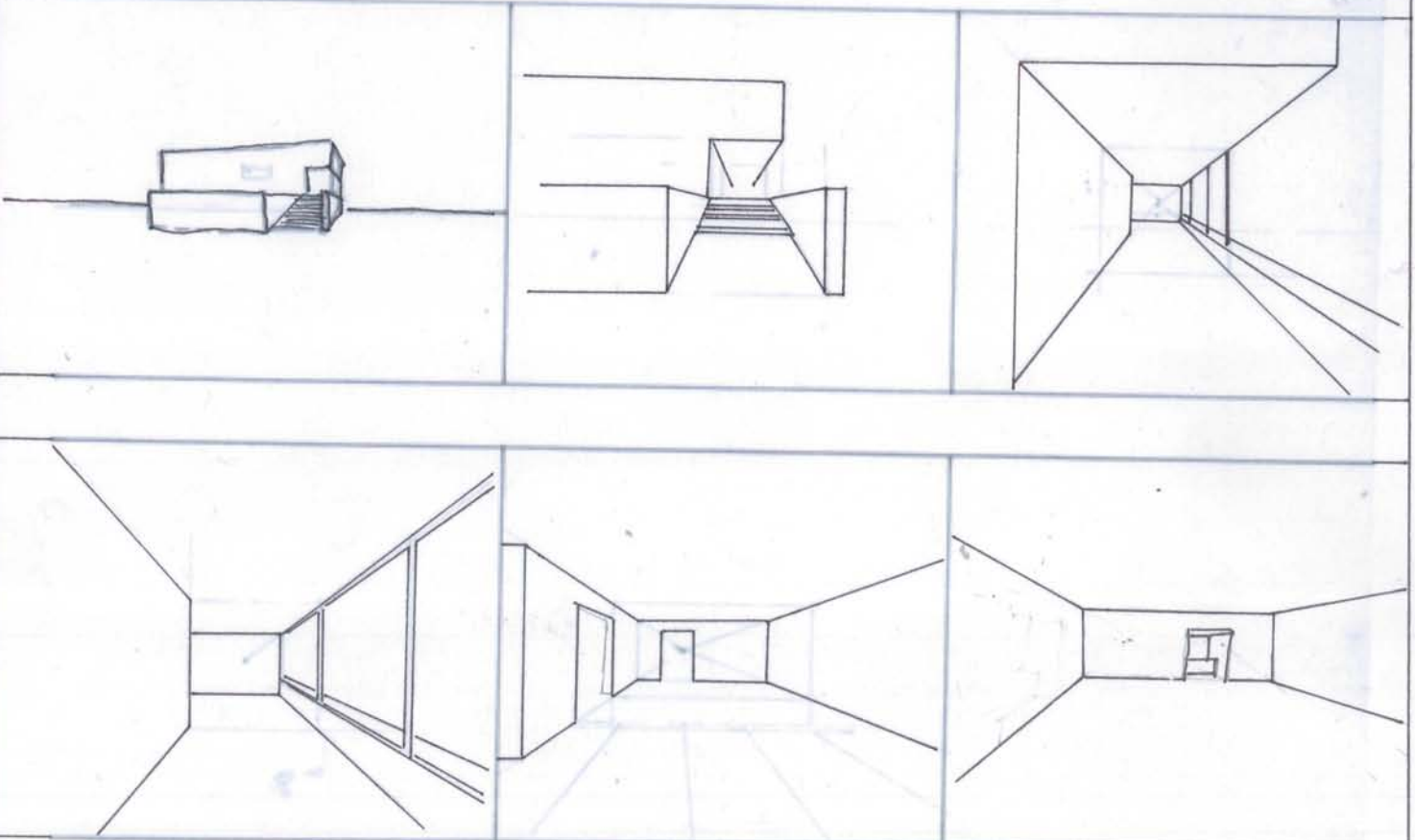
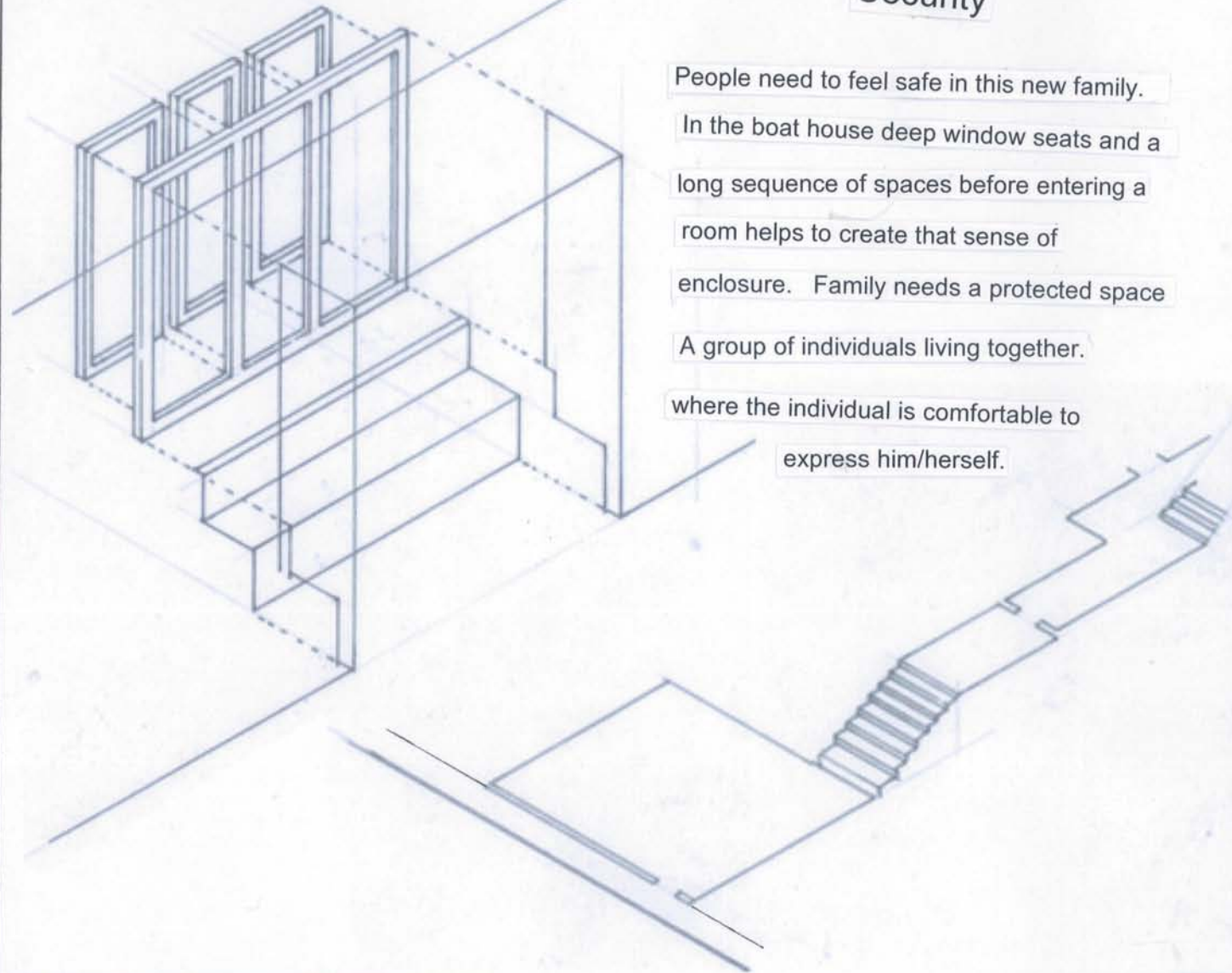

Interaction

Interaction between people will be needed, so that they can develop the meaningful relationships that are present in every family.

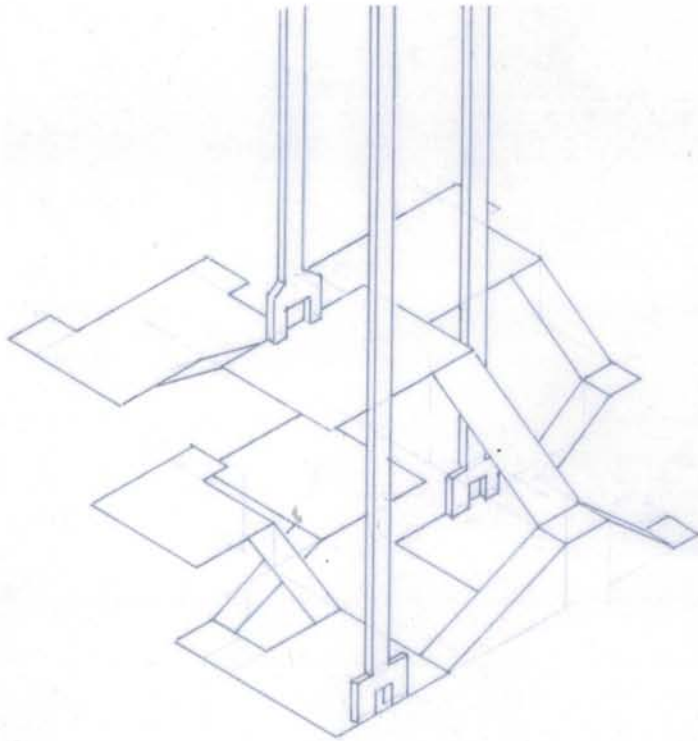
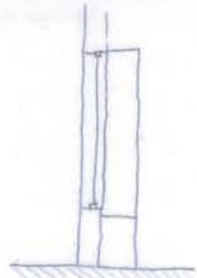
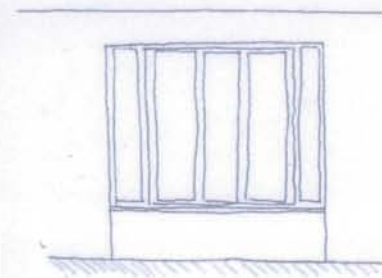
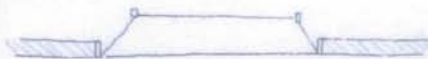
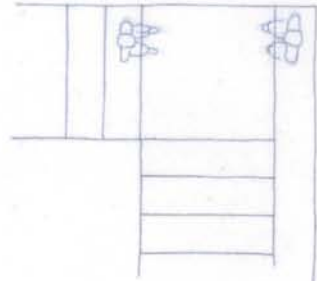
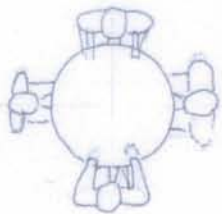
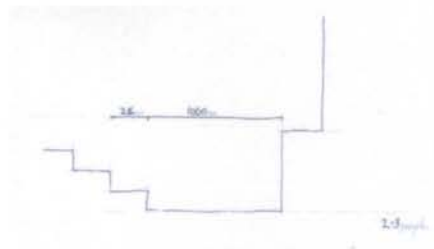
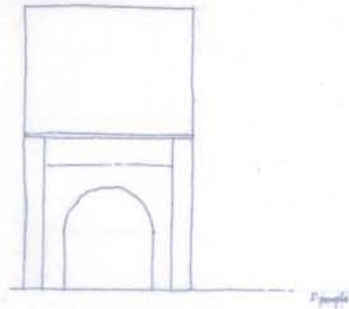
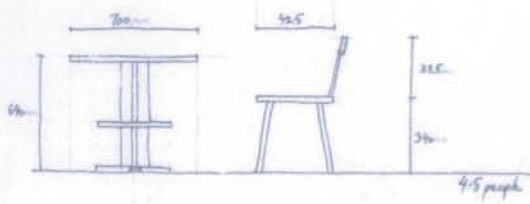
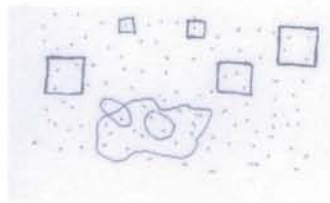
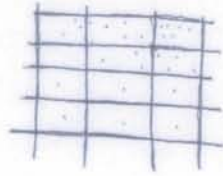

Flexibility

"The body of persons who live in one house"

"A group or assemblage connected together and distinguished from others by the possessions of some common features or properties."

"A brotherhood of individuals bound together by political or religious ties."

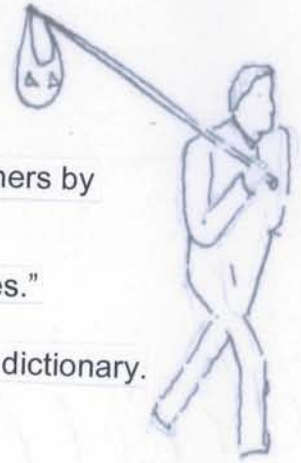

Three different definition of family found in Collins English dictionary.

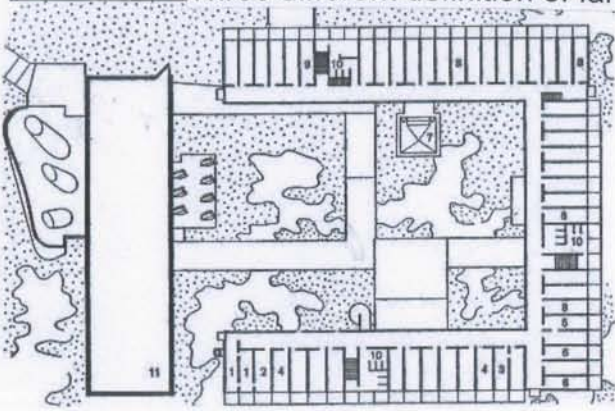

La Tourette Monastery

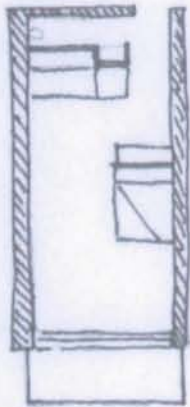

One bedroom apartment

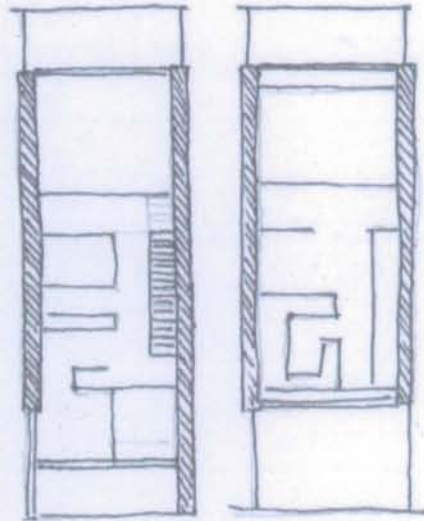

Two bedroom apartment

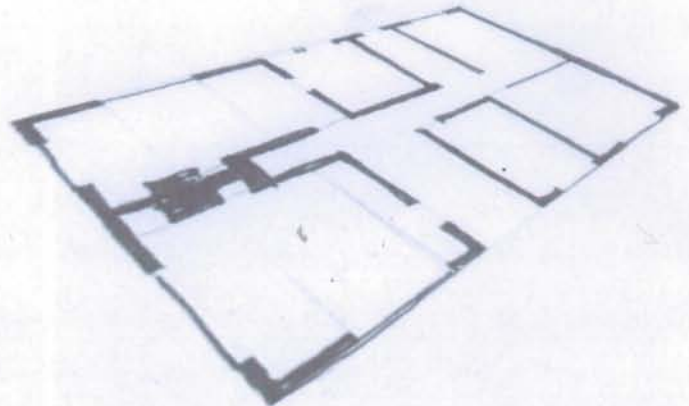
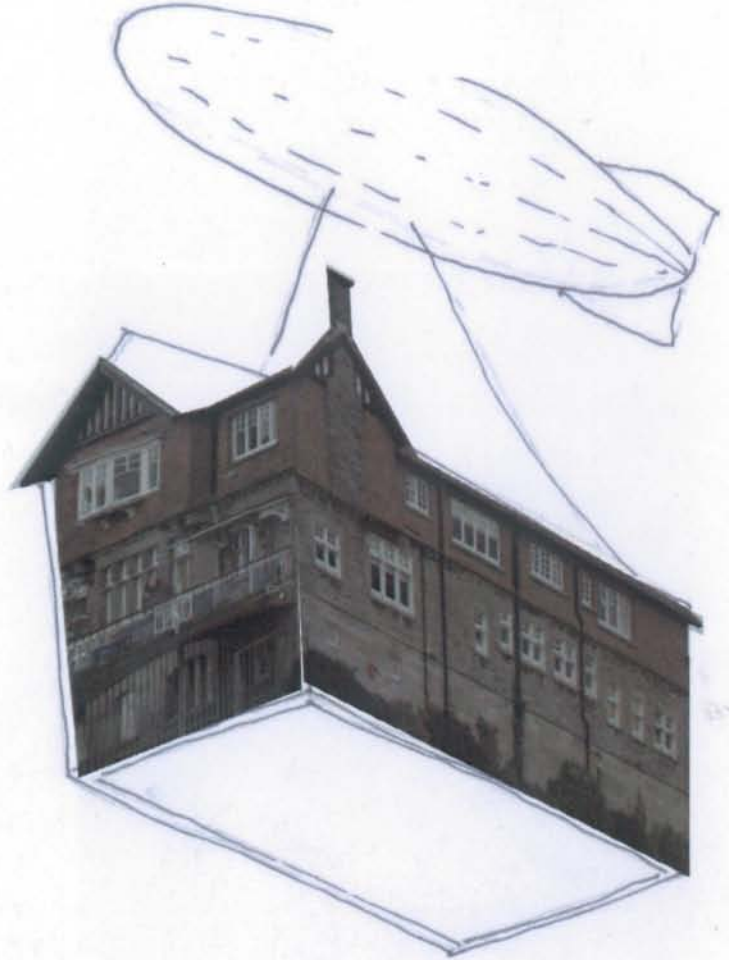

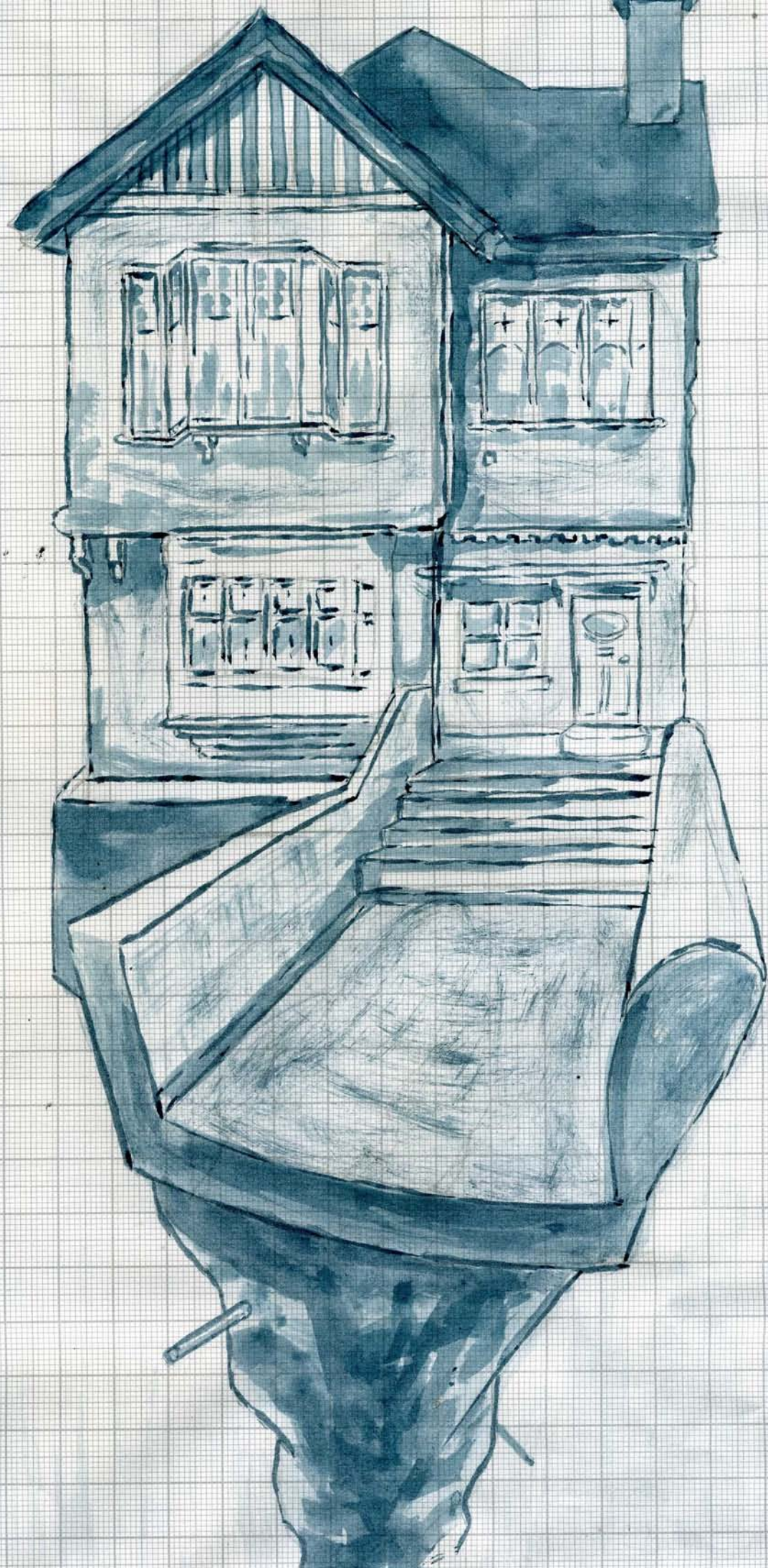

HYBRID HOUSING COMMUNE AT THE SHANNON ROWING CLUB

House ship housing estate along the Shannon for the home dweller on the move



1.

4.

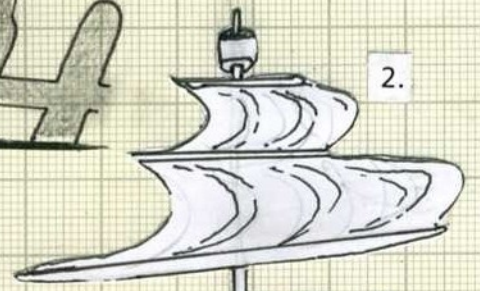

2.

1. Detachable entrance for easy mobility
2. Mast for sailing
3. Diving board to promote healthy living
4. Communal outdoor bar to promote neighbourhood interaction
5. Relaxation room
6. Fishing post for sustainable living
7. Water turbine and solar panels for renewable energy

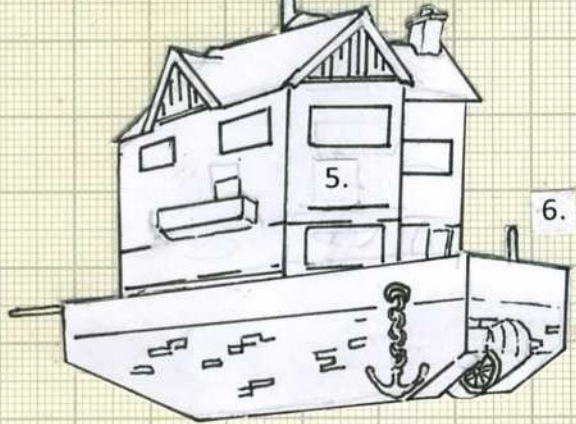

3.

5.

6.

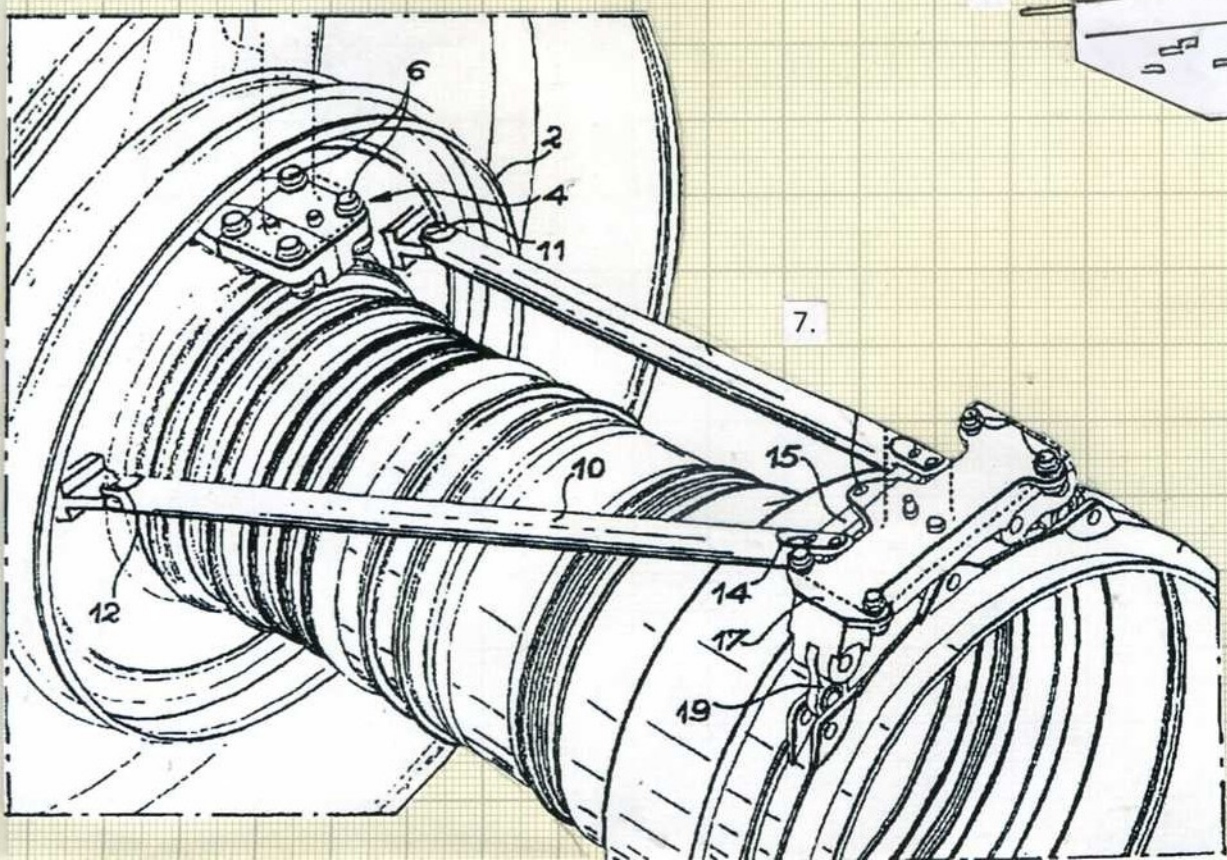

7.







Empty Nesters is a collaboration between an architect
and an artist...

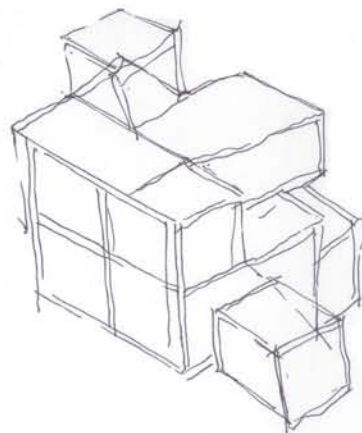

Contact

www.emptynesterscommune.weebly.com

All artwork by

Shane Harrington and Philip Dawson

